

VEGA 580 x 943

mm mm

V-2338 P/B/O

23 x 37 inches

Elettrico / electric / électrique

CODICE / CODE

RS162008SS	RS172008SS
RL162008SS	RL172008SS
RV162008SS	RV172008SS
220v	115v

W

580 mm
22 7/8 inches

H

943 mm
37 1/8 inches

REGOLATORE DI POTENZA
HEAT CONTROLLER DEVICE
RÉGULATEUR DE PUISSANCE

INGOMBRO CON ATTACCO LUNGO
MEASURES WITH LONG BRACKETS
MEASUREMENT AVEC ATTACHE LONG

INGOMBRO CON ATTACCO STANDARD
MEASURES WITH STANDARD BRACKETS
MEASUREMENT AVEC ATTACHE STANDARD

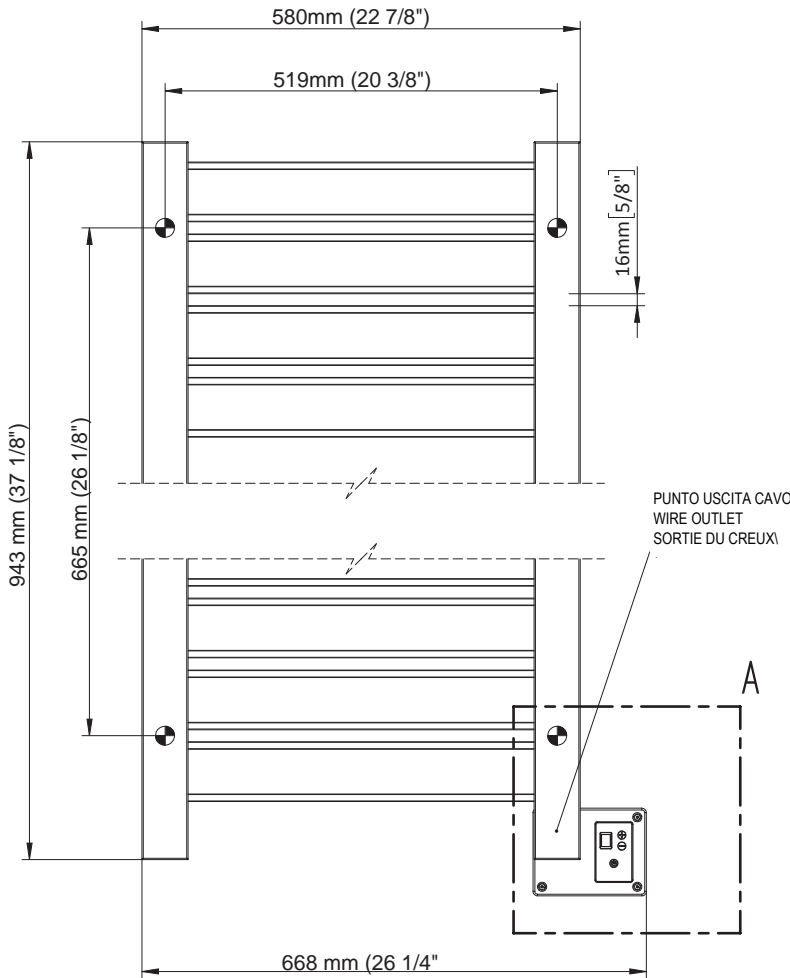

DETAIL A

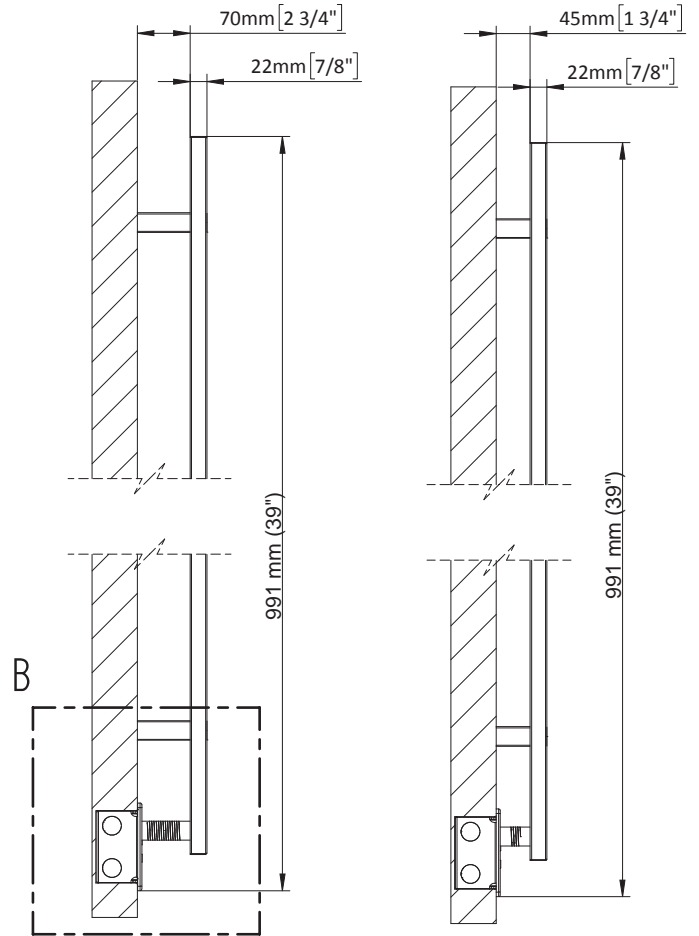

DETAIL B

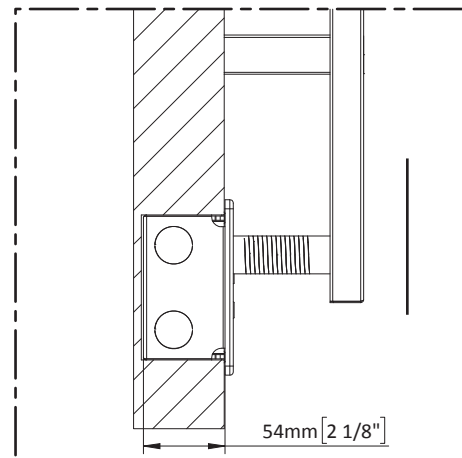
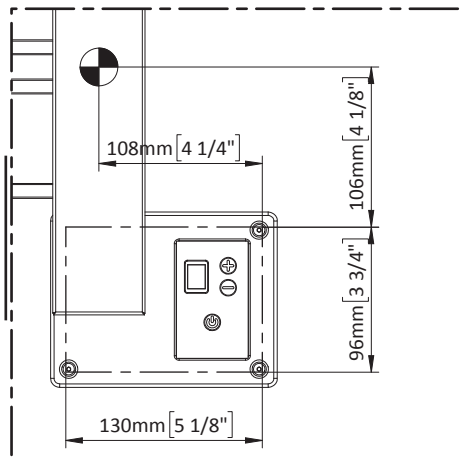

FORO PER INSERIMENTO TASSELLO A MURO 6X30
POSITIONING OF FASTENERS FOR FIXING TO WALL
FASTENERS SHOULD BE SECURED IN STUDS OR HEADERS PLACED BEHIND THE UNIT
TROU POUR LA CHEVILLE A MUR

