



3509-1

Features

- Available in 28 finishes including 13 PVD finishes
- All brass construction
- 5-5/16" spout center to center
- Single handle operation cartridge with ceramic disc
- Flexible braided hoses for ease of installation
- 1.2gpm (4.5 L/min) max flow rate

Codes/Standards Applicable

Product meets or exceeds the following:

- ASME A112.18.1/CSA B125.1
- NSF 61, NSF 372, CEC & DOE
- EPA WaterSense
- Commonwealth of MA
- ADA compliant



3509-1-SN shown

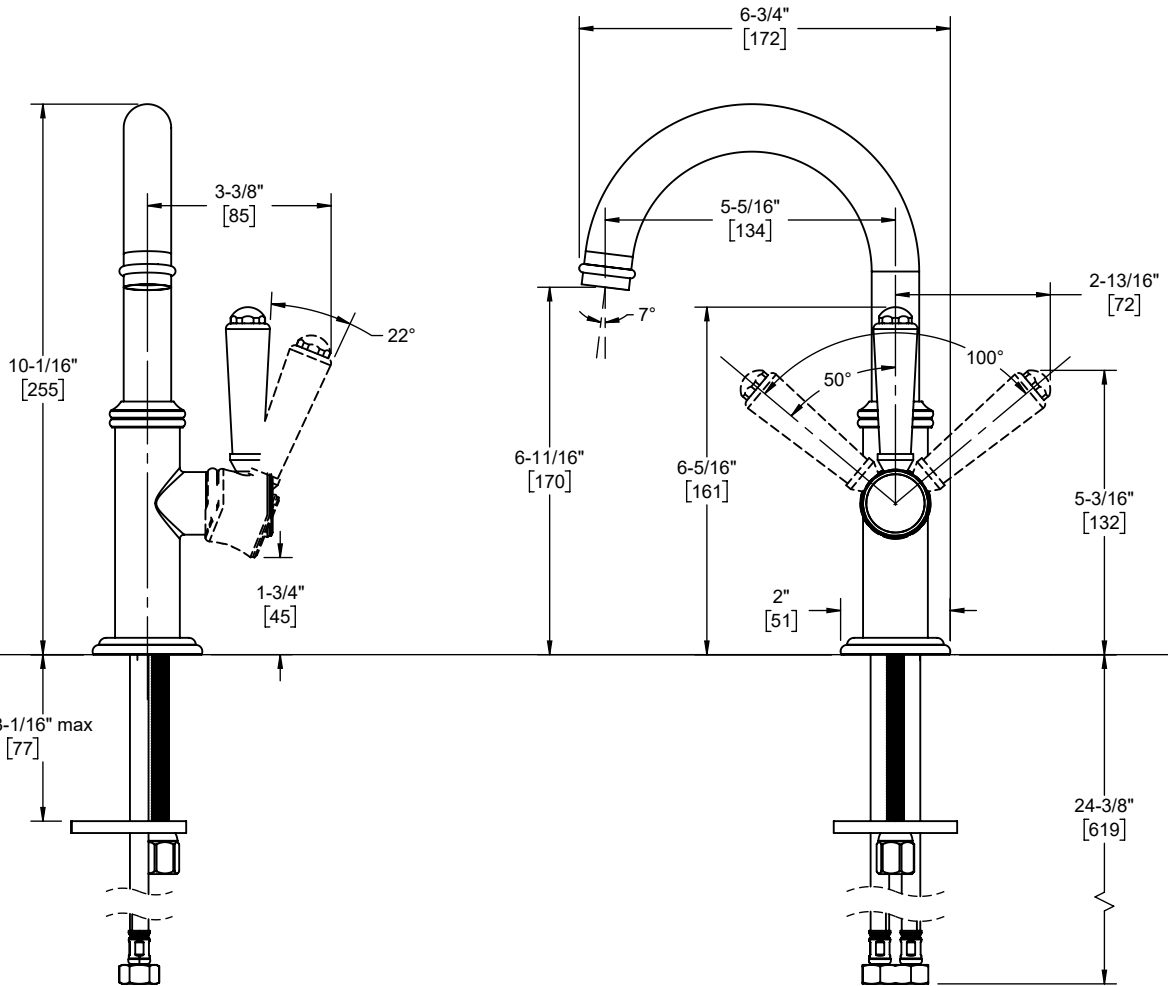

Through-Hole Specifications

Min	Recommended	Max
Ø1-1/4"	Ø1-3/8"	Ø1-9/16"
[32]	[35]	[40]

Specifications subject to change without notice

Dimensions are inches, rounded to 1/16"
[Dimensions in brackets are mm, rounded to 1mm]