



Tuzio® Sorano Towel Warmer Installation Guide

**Code: H4403 / H4404 / H4405 / H4406
23.5" x 47.5" Hydronic**

**Technical Helpline:
Toll-Free 1-877-757-8990
www.icocanada.com**



3005 Saskatchewan Drive
Regina, SK | S4T 1H5

toll free | 1 877 757 8930
tel | 306 757 8941 fax | 306 757 8940

Congratulations!

You are the proud owner of a quality Tuzio Towel Warmer.

This product has been specifically engineered and tested to provide optimal comfort and satisfaction.

ICO carries a broad range of luxury bathroom products designed to make everyday living just a little more enjoyable! Visit www.icocanada.com to learn more.

Contents

Rough-In Requirements For Constant Circulation Heating System	Page 3
Rough-In Requirements For Dedicated Heating System	Page 4
Installation Instructions	Page 5
Valve Connection	Page 5
Specifications & Drawings – Wall Rough-In	Page 6
Specifications & Drawings – Floor Rough-In	Page 7

Towel Warmer Installation Procedure



① Rough-in Requirements - for constant circulation heating system (see figure 1)

Using this installation method, the towel warmer is controlled using the valves attached to the towel warmer, and can be operated independently from the heating system. This method of installation is popular where there are multiple heating appliances connected to a closed hot water heating system, and electronic control of the individual towel warmer is not important. Thermostatic valves are recommended in these installations. (see figure 5)

1. Install heating system pipework to proposed towel warmer location and tee off the main circuit to provide a branch circuit for the towel warmer. Piping to towel warmer valves should be 1/2" copper.
2. If towel warmer supply pipes are coming through wall, rough-in pipes as per locations shown on fig 4. If towel warmer supply pipes are coming through floor, rough-in pipes as per locations shown on fig 7.
3. If a hydronic installation pack is being used (see figs 5 & 8), these should be connected (solder connected) within the wall / floor. If a hydronic installation pack is not being used (see figs 6 & 9), these 1/2" copper supply lines should protrude through wall/floor in order to connect to towel warmer valves.
4. Wall studs or plywood backing is required in the wall at all bracket locations. See figure 4 for bracket locations.

fig. 1

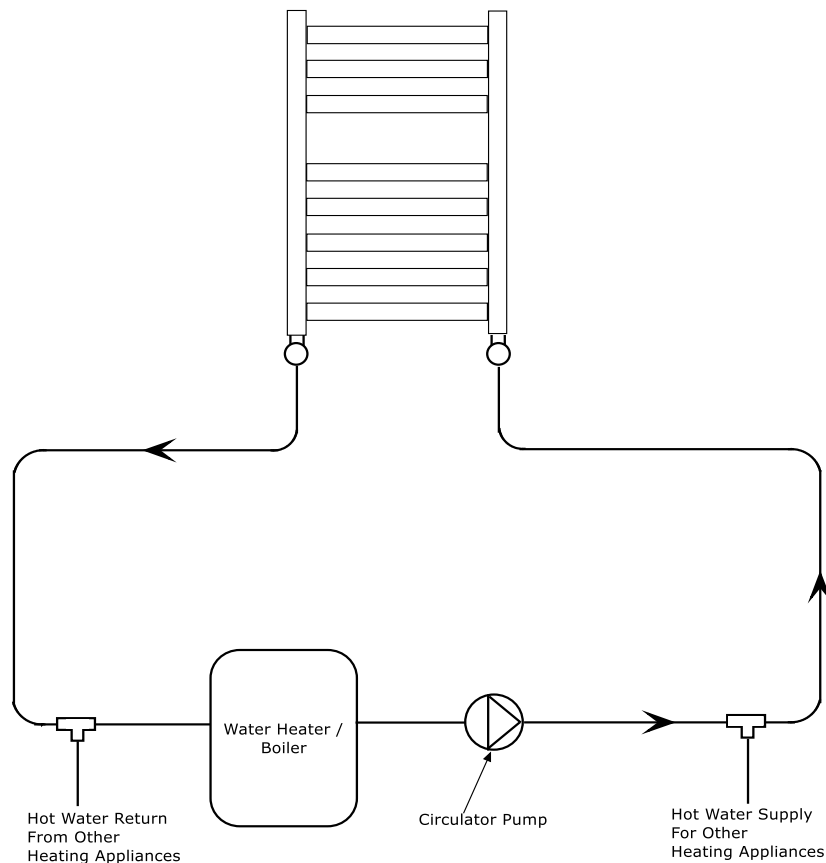

Towel Warmer Installation Procedure



① Rough-in Requirements - for dedicated heating system (see figure 2)

Using this installation method, the towel warmer is controlled using the thermostat wired to the circulator pump, and cannot be operated independently from the heating system. This method of installation is popular where there is only one heating appliance connected to a closed hot water heating system, and electronic control of the individual towel warmer is required.

1. Install heating system pipework to proposed towel warmer location. Piping to towel warmer valves should be 1/2" copper.
2. If towel warmer supply pipes are coming through wall, rough-in pipes as per locations shown on fig 4. If towel warmer supply pipes are coming through floor, rough-in pipes as per locations shown on fig 7.
3. If a hydronic installation pack is being used (see figs 5 & 8), these should be connected (solder connected) within the wall / floor. If a hydronic installation pack is not being used (see figs 6 & 9), these 1/2" copper supply lines should protrude through wall/floor in order to connect to towel warmer valves.
4. Wall studs or plywood backing is required in the wall at all bracket locations. See figure 4 for bracket locations.

fig. 2

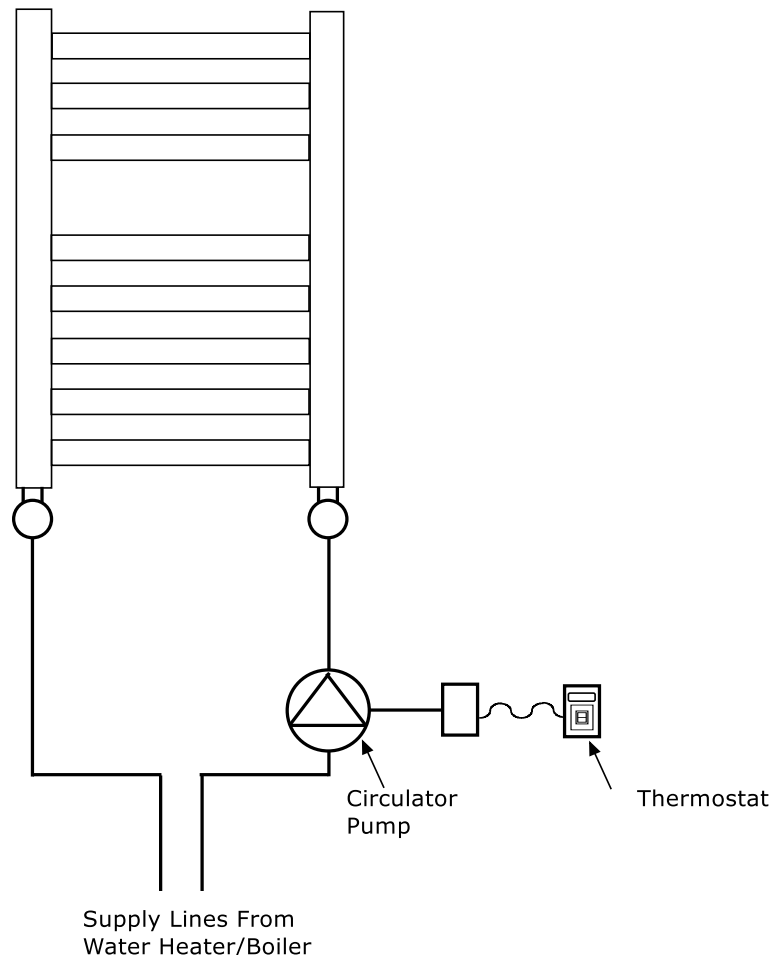

Towel Warmer Installation Procedure



2 Installation Instructions (see figure 3)

1. Check all items have been received. You should have Towel Warmer and mounting bracket kit. Read all instructions before continuing.
2. Fix wall supports "B" including collar "A" to the wall using the screws provided and in locations as shown on figure 2.
3. Screw the threaded pin "C", into the threaded bushing "D".
4. Hang and adjust the Towel Warmer using set screws "E" to lock pin "C" in the wall bracket "B". Ensure the Towel Warmer is firmly and safely fixed.

fig. 3

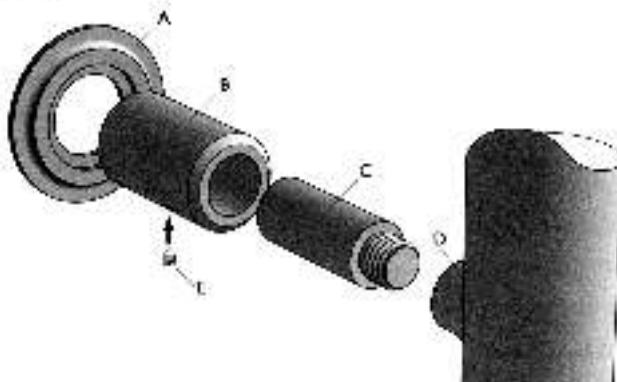

3 Valve Connection (see figure 5, 6, 8 or 9)

1. If using a hydronic installation pack, slide escutcheon (supplied with hydronic installation pack) over 1/2" supply pipe.
2. Unscrew male threaded components including collars from valve and thread into female inlets at bottom of towel warmer using a 12mm allen key wrench.
3. Push compression fitting on to 1/2" supply pipe and tighten 1/2" compression fitting collar on valve.
4. Seat male threaded component (now connected to towel warmer) on valve and tighten collar.
5. Insert blank plug and air vent plug (supplied with bracket kit) into top female inlets on towel warmer.
6. Check for leaks and bleed system if necessary using air vent plug.

Warning: All hydronic plumbing connections should be made in accordance with local and national plumbing regulations. It is the responsibility of the plumber to ensure plumbing system and towel warmer installation comply with these regulations.



Specifications & Drawings (wall rough-in)



Model #	Description	Finish	Weight (lb)	Output	WxH (mm)	WxH (Inches)	Metal Type
H4403	Sorano Hydronic	Chrome	23.1	1604Btu	600 x 1210	23.5" x 47.5"	Mild Steel
H4404	Sorano Hydronic	Brushed Nickel	23.1	1604Btu	600 x 1210	23.5" x 47.5"	Stainless Steel
H4405	Sorano Hydronic	Matte Black	23.1	1604Btu	600 x 1210	23.5" x 47.5"	Mild Steel
H4406	Sorano Hydronic	Polished Nickel	23.1	1604Btu	600 x 1210	23.5" x 47.5"	Mild Steel
A1043	Thermostatic Angle Valve	Chrome	2.0	-	-	-	Brass
A1044	Thermostatic Angle Valve	Brushed Nickel	2.0	-	-	-	Brass
A1045	Thermostatic Angle Valve	Matte Black	2.0	-	-	-	Brass
A1046	Thermostatic Angle Valve	Polished Nickel	2.0	-	-	-	Brass
A3013	10" Installation Pack	Chrome	0.4	-	-	-	Copper
A3014	10" Installation Pack	Brushed Nickel	0.4	-	-	-	Copper
A3015	10" Installation Pack	Matte Black	0.4	-	-	-	Copper
A3016	10" Installation Pack	Polished Nickel	0.4	-	-	-	Copper

Material Specifications: Mild Steel - Din 2394 Quality - ST 34-2 KB or Stainless Steel - Din 17457 - Quality 1.4301

Warranty: 5 years

Fixings: Screws and fixings are included

Hydronic System: Hydronic towel warmer should be used only on a closed system incorporating an anti-rust inhibitor.

Care & Maintenance: A periodic wash using warm water and a soft cloth will retain the high quality finish of your towel warmer for many years to come. ON NO ACCOUNT should any household bleaches, detergents, abrasive polishes, steel wool or other cleaning agents be used on this item. **IMPORTANT:** Circuit temperature must not exceed 158° Fahrenheit.

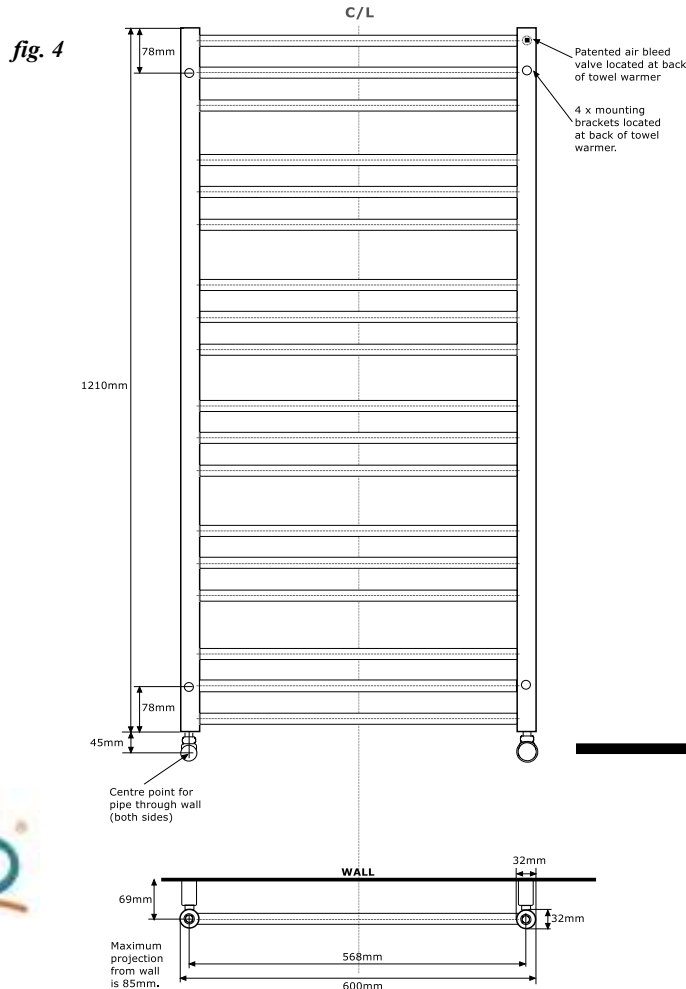

Specifications & Drawings (floor rough-in)



Model #	Description	Finish	Weight (lb)	Output	WxH (mm)	WxH (Inches)	Metal Type
H4403	Sorano Hydronic	Chrome	23.1	1604Btu	600 x 1210	23.5" x 47.5"	Mild Steel
H4404	Sorano Hydronic	Brushed Nickel	23.1	1604Btu	600 x 1210	23.5" x 47.5"	Stainless Steel
H4405	Sorano Hydronic	Matte Black	23.1	1604Btu	600 x 1210	23.5" x 47.5"	Mild Steel
H4406	Sorano Hydronic	Polished Nickel	23.1	1604Btu	600 x 1210	23.5" x 47.5"	Mild Steel
A1053	Thermostatic Straight Valve	Chrome	2.0	-	-	-	Brass
A1054	Thermostatic Straight Valve	Brushed Nickel	2.0	-	-	-	Brass
A1055	Thermostatic Straight Valve	Matte Black	2.0	-	-	-	Brass
A1056	Thermostatic Straight Valve	Polished Nickel	2.0	-	-	-	Brass
A3103	30" Installation Pack	Chrome	1.0	-	-	-	Copper
A3104	30" Installation Pack	Brushed Nickel	1.0	-	-	-	Copper
A3105	30" Installation Pack	Matte Black	1.0	-	-	-	Copper
A3106	30" Installation Pack	Polished Nickel	1.0	-	-	-	Copper

Material Specifications: Mild Steel - Din 2394 Quality - ST 34-2 KB or Stainless Steel - Din 17457 - Quality 1.4301

Warranty: 5 years

Fixings: Screws and fixings are included

Hydronic System: Hydronic towel warmer should be used only on a closed system incorporating an anti-rust inhibitor.

Care & Maintenance: A periodic wash using warm water and a soft cloth will retain the high quality finish of your towel warmer for many years to come. ON NO ACCOUNT should any household bleaches, detergents, abrasive polishes, steel wool or other cleaning agents be used on this item. **IMPORTANT:** Circuit temperature must not exceed 158° Fahrenheit.

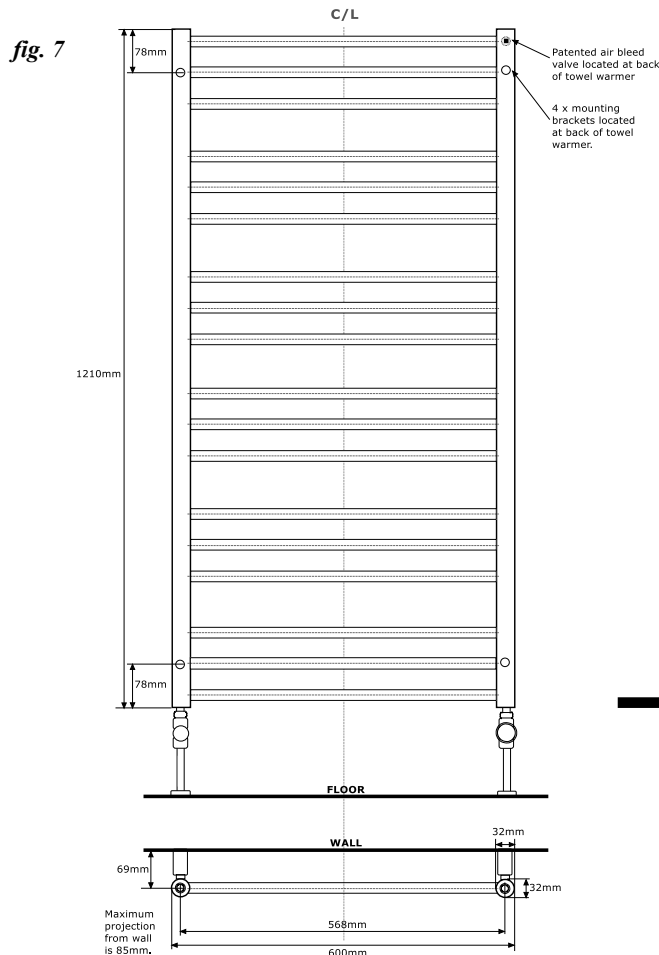

Tuzio®

OSY
BOARD

OSY®
FLOOR



Towel Warmers



Electric In-Floor Heating



Insulation Board



Bathroom Luxury

info@icocanada.com
www.icocanada.com

toll-free | 1 877 757 8930
tel | 306 757 8941 fax | 306 757 8940

3005 Saskatchewan Drive
Regina, SK | Canada | S4T 1H5