

12" Deluxe Grab Bar with Contemporary Round Flange

Model #: 2612-



FEATURES:

- ADA compliant when properly installed
- Complements Contempo & Astor collections
- Covers standard 3" flange on stainless steel grab bars
- No need to re-tile in retro-fit applications
- 1 1/4" diameter
- 12" center post to center post
- For large quantity custom lengths contact hospitality@jaclo.com

AVAILABLE FINISHES:

Polished Chrome (PCH)	Satin Chrome (SC)	Bronze Umber (BU)
Satin Nickel (SN)	Pewter (PEW)	Caramel Bronze (CB)
Polished Nickel (PN)	Antique Brass (AB)	Antique Copper (ACU)
Oil-Rubbed Bronze (ORB)	Polished Brass (PB)	Polished Copper (PCU)
Vintage Bronze (VB)	Satin Brass (SB)	Rose Gold (RG)
Matte Black (MBK)	Satin Gold (SG)	Polished Gold (PG)
Black Nickel (BKN)	Bombay Gold (BG)	Jewelers Gold (JG)
Europa Bronze (EB)	White (WH)	Sedona Beige (SDB)
Tristan Brass (TB)	Unlacquered Brass (ULB)	Satin Cooper (SCU)

SPECIFICATION DRAWING:

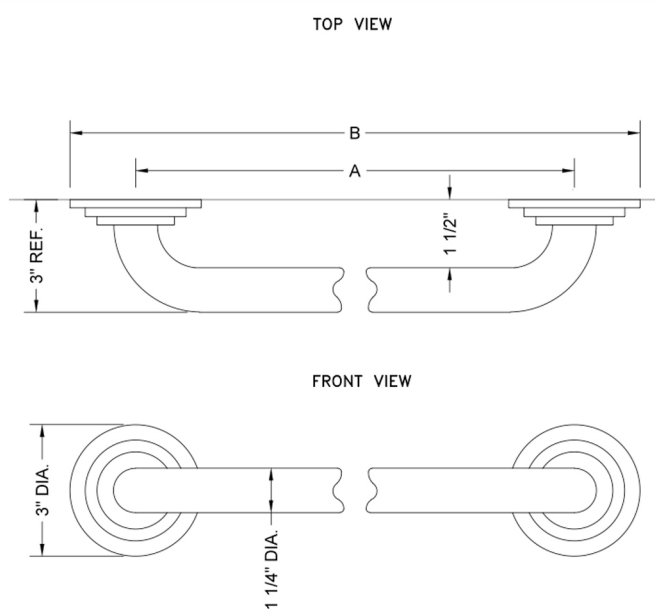

GRAB BAR W/ CONTEMPORARY ROUND FLANGE			
PART. #	DESCRIPTION	A	B
2612	12" GRAB BAR	12"	15"
2616	16" GRAB BAR	16"	19"
2618	18" GRAB BAR	18"	21"
2624	24" GRAB BAR	24"	27"
2632	32" GRAB BAR	32"	35"
2636	36" GRAB BAR	36"	39"
2642	42" GRAB BAR	42"	45"
2648	48" GRAB BAR	48"	51"