

### Features

- Generous 6-foot length provides spacious bathing for up to two people.
- Molded lumbar support offers extra comfort while bathing.
- Slotted overflow allows for deep soaking.
- Center drain.
- Under-mountable

### Material

- Acrylic

### Installation

- Drop-in or under-mount.

### Additional Hydrotherapy Options

- Soaking Bath - 1137-0
- Soaking Bath + Bask heated surface - 1137-W1
- BubbleMassage air bath - 1174-G
- BubbleMassage air bath + chromatherapy - 1174-GCR
- VibrAcoustic + BubbleMassage air bath - 1174-GVB
- VibrAcoustic + BubbleMassage air bath + Bask heated surface + chromatherapy - 1174-GVBCW
- Whirlpool + heater - 1174-H2
- VibrAcoustic - 1174-VB
- VibrAcoustic + chromatherapy - 1174-VBC
- VibrAcoustic + chromatherapy + Bask heated surface - 1174-VBCW
- VibrAcoustic + Bask heated surface - 1174-VBW
- Whirlpool + BubbleMassage air bath - 1174-XH2G

### Required Products/Accessories

K-7271 Brass Slotted Overflow Bath Drain

or

K-7272 PVC Slotted Overflow Bath Drain

### Recommended Products/Accessories

K-592 Under-Mount Installation Kit

K-24916 Wireless Music Kit

K-1601 Bath/Whirlpool Footstop



### Codes/Standards

CSA B45.5/IAPMO Z124

ASTM E162









ASTM E662

### KOHLER® Plastic Baths and Receptors Lifetime Limited Warranty

See website for detailed warranty information.

### Available Colors/Finishes

*Color tiles intended for reference only.*

Color	Code	Description
	0	White
	96	Biscuit
	47	Almond
	NY	Dune
	95	Ice™ Grey
	G9	Sandbar
	K4	Cashmere
	58	Thunder™ Grey
	7	Black Black™

No change in measurements if connected with drain illustrated. (K-7272)

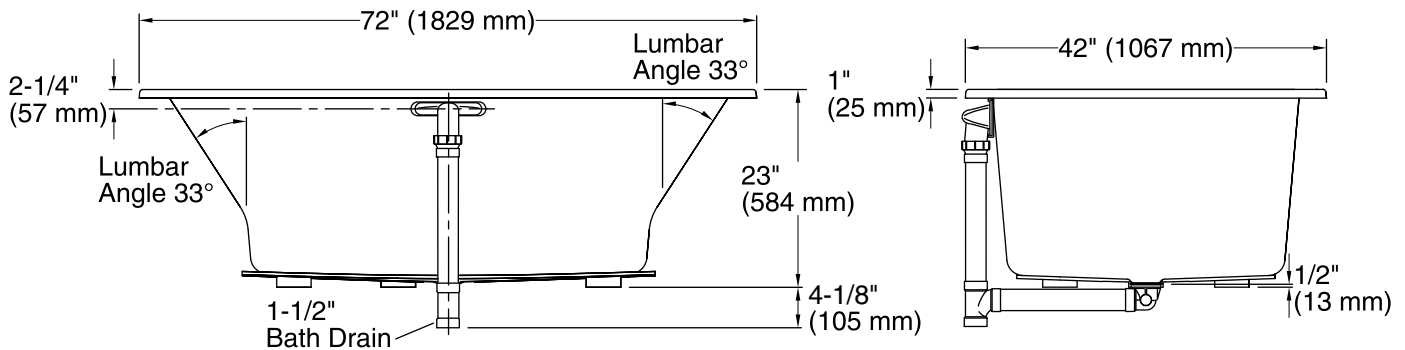
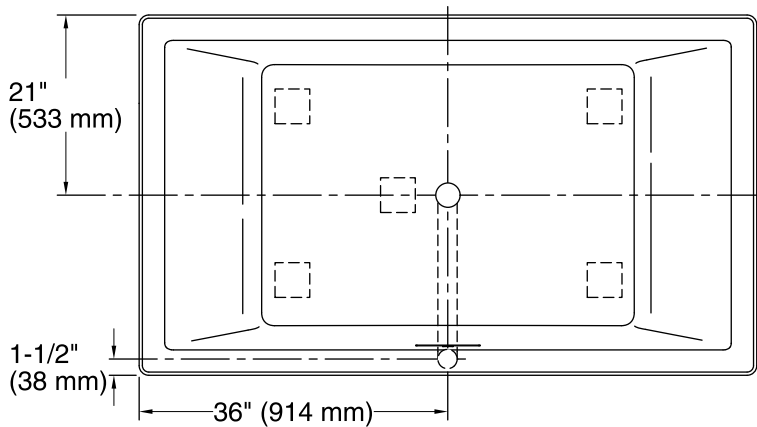

### Technical Information

All product dimensions are nominal.

Installation:	Drop-in, Under-mount
Drain location:	Center
Basin area, bottom:	45-3/4" x 32" (1162 mm x 813 mm)
Basin area, top:	66" x 36" (1676 mm x 914 mm)
Weight:	85 lbs (38.6 kg)
Minimum floor load:	60 lbs/ft <sup>2</sup> (292.9 kg/m <sup>2</sup> )
Water depth:	19" (483 mm)
Water capacity:	139 gal (526.2 L)
Cutout:	Drop-in, 70-1/2" x 40-1/2" (1791 mm x 1029 mm)
Minimum flat for door:	2-9/16" (66 mm)

### Notes

Measure your actual product for rough-in details.

Install this product according to the installation instructions.

The hot water supply should be 70% of the capacity of the bath or greater. Installations will vary.

Kit is required for under-mount installations (sold separately).