

Features

- 0.5 gpf (1.9 lpf)
- Activation distance is factory-set
- Chloramine and chlorine resistance on all rubber components exposed to waterway
- Engineered for optimal performance with KOHLER® commercial fixtures
- 125-micron filter protects internal components
- High back pressure vacuum breaker
- Locking stop cap provides protection against vandalism
- No external flush volume adjustment ensures water conservation
- 24-hour automatic sentinel flush keeps trapway fresh
- Mechanical override enables flushometer to be used manually even during a power outage
- Powered by a 30 year/875,000 cycle hybrid energy cell, based on 72 uses per day

Material

- Brass construction with durable Polished Chrome finish

Technology

- Flushometer activates when hand is waved over electronic infrared WAVE sensor
- Patented piston technology for superior flush volume accuracy

Installation

- Intended for urinal installations with 3/4" (19 mm) top spud coupling connection

Recommended Products/Accessories

K-23723 Faucet cleaner
1421939
1509698

Optional Products/Accessories

GP1118986
K-10313 Flushometer 12" rough-in kit



Codes/Standards

ASME A112.18.1/CSA B125.1
ASSE 1037/ASME A112.1037/CSA B125.37
EPA WaterSense®
ADA
ICC/ANSI A117.1
CSA B651
OBC

KOHLER® One-Year Limited Warranty

See website for detailed warranty information.

Available Colors/Finishes

Color tiles intended for reference only.

Color	Code	Description
	CP	Polished Chrome

*10-3/4" (273 mm) minimum with a
 6" (152 mm) critical level above the fixture

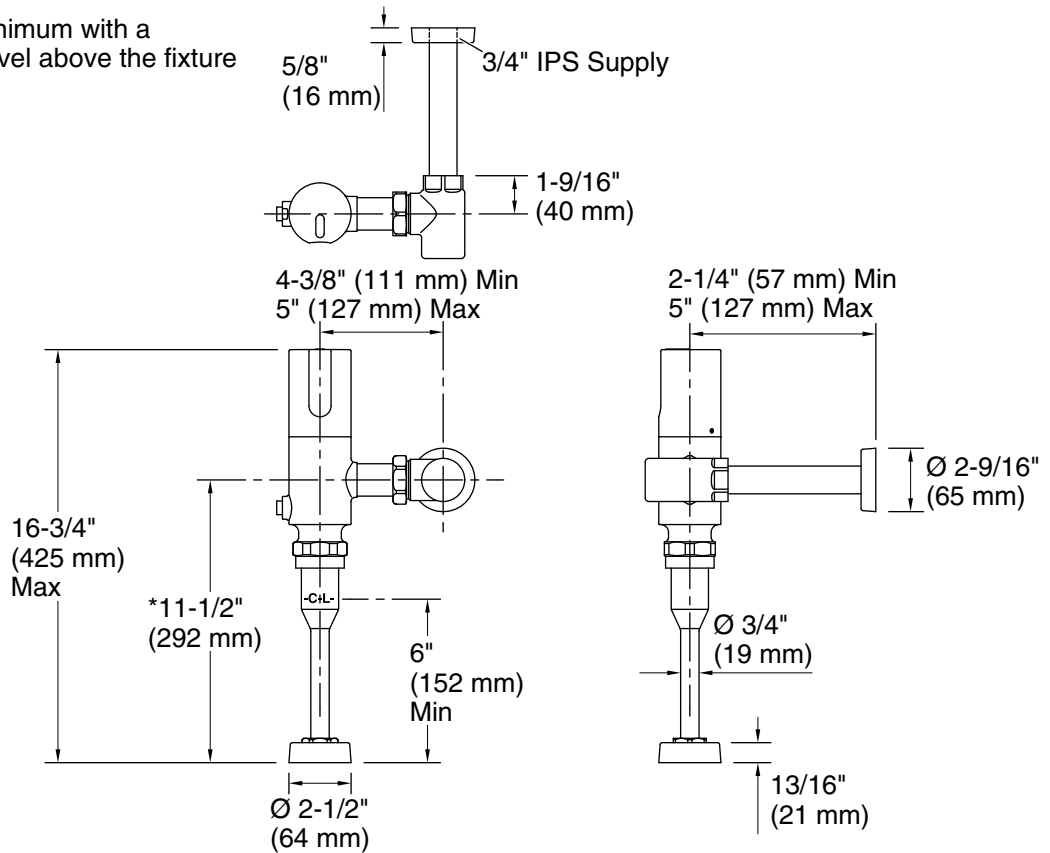

Technical Information

All product dimensions are nominal.

Pressure/fixture Supply Requirements

Fixture pressure max (static):	80 psi (551.6 kPa)
Fixture pressure min (static):	25 psi (172.4 kPa)
Min flowing pressure:	25 psi (172.4 kPa)
Min flow rate:	25 gpm (94.6 lpm)

Notes

Install this product according to the installation instructions.

ADA, OBC, CSA B651 compliant when installed to the specific requirements of these regulations.