

## Features

- 33-inch minimum base cabinet width.
- Double equal bowls.
- 9-inch depth.
- Three faucet holes with one accessory hole to the right.
- Bowl slopes 2 degrees toward drain to minimize water pooling.
- Offset drains increase workspace in the sink and storage space underneath.
- Includes K-6239 colander with integral cutting board and K-9238 bottom sink rack.

## Material

- KOHLER® enameled cast iron.

## Installation

- Top-mount

## Recommended Products/Accessories

K-9000 P-Trap  
K-9238 Sink Rack  
K-6377 Sponge Caddy  
K-6378 Kitchen Brush Caddy  
K-6379 Kitchen Squeegee  
K-6382 Disinfecting Wipes Dispenser  
K-6383 Soap Dispenser  
K-8618 Paper Towel Holder  
K-8619 Flexible Kitchen Mat  
K-8624 Dish Scraper  
K-8801 Sink Strainer  
K-8799 Sink Strainer

## Included Components

Product consists of:

K-9238 Sink Rack  
K-6239 Colander with Cutting Board



## Codes/Standards











ASME A112.19.1/CSA B45.2

## KOHLER® Enameled Cast Iron Kitchen Sink Lifetime Limited Warranty

See website for detailed warranty information.

## Available Colors/Finishes

*Color tiles intended for reference only.*

Color	Code	Description
	0	White
	FF	Sea Salt™
	96	Biscuit
	47	Almond
	FD	Cane Sugar™
	95	Ice™ Grey
	G9	Sandbar
	K4	Cashmere
	20	Suede
	KA	Black 'n Tan
	7	Black Black™

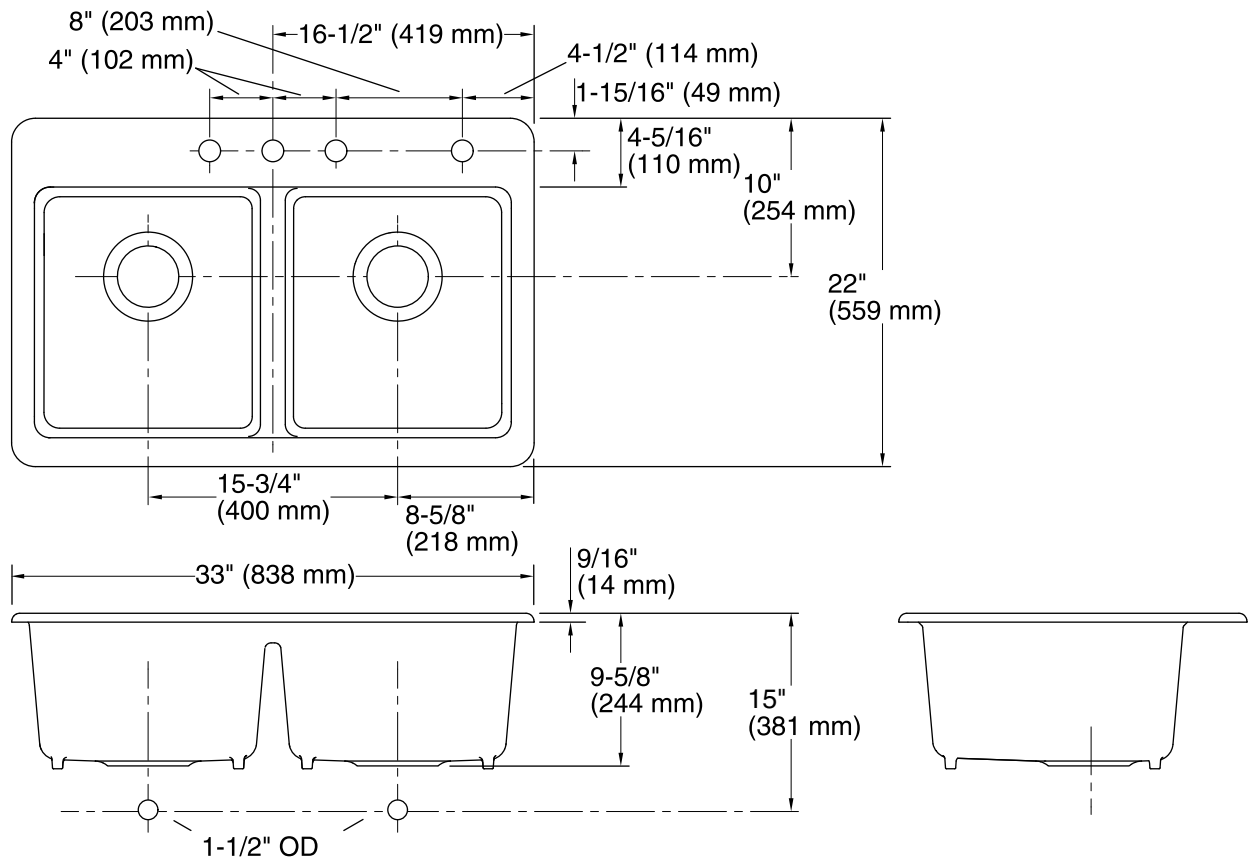

## Technical Information

All product dimensions are nominal.

Installation:	Top-mount
Min. base cabinet width:	33" (838 mm)
Bowl area (Left):	Length: 14-5/16" (363 mm) Width: 17-1/4" (438 mm) Bowl depth: 9" (229 mm) Water depth: 9" (229 mm)
Bowl area (Right):	Length: 14-5/16" (363 mm) Width: 17-1/4" (438 mm) Bowl depth: 9" (229 mm) Water depth: 9" (229 mm)
Number of deck holes:	4
Faucet hole spacing:	4" (102 mm)
Template:	1166727-7, required, included

## Notes

Install this product according to the installation instructions.