

KGTW2-33

33 Inch Workstation Single Bowl Granite Top Mount Kitchen Sink

Kräus®

SPECIFICATION SHEET

Sink Dimensions

Overall Dimensions: 33" x 22"

Bowl Dimensions: 30" x 16"

Sink Depth: 9 5/8"

Features

- Granite Composite Construction
- Top Mount Single Bowl Sink
- Required Minimum Cabinet Size: 36" Left to Right, 24" Front to Back
- Rear Off-Set Drain
- 3 1/2" Drain Opening

Accessories Included

- Cutting Board KCB-WS303SA
- Sink Strainer ST-4
- Rolling Mat KRM-11BL

Available Colors

- Metallic Black
- Metallic Brown
- Metallic Grey

CODES/STANDARDS:

Product Certification
cUPC

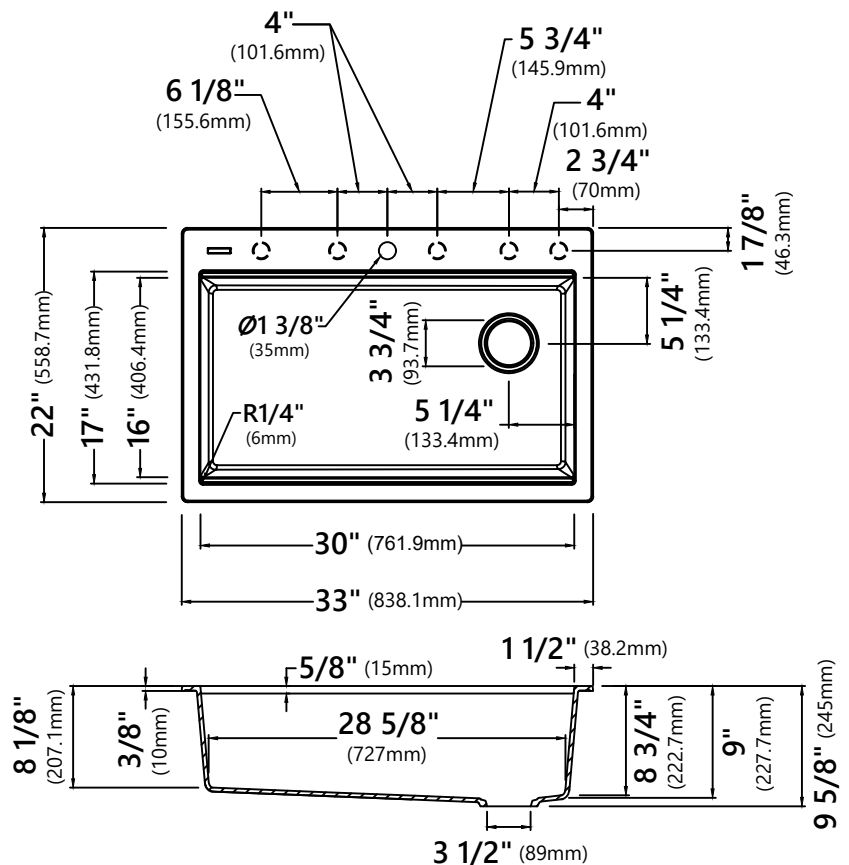

NOTE: 1 3/8" (35mm) diameter faucet holes are pre-scored. The installer can knock out up to 6 faucet holes.

NOTE: Although Kraus granite and quartz composite sinks are highly heat resistant, placing hot items right from the stove or oven directly into the sink may cause surface discoloration. Consider using a trivet or rolling mat for extremely hot items to avoid potential heat damage.

NOTE: It is not recommended to install this sink with a negative reveal. Doing so will prohibit the use of any workstation accessories as they will not fit.

Warranty

Kraus Limited Lifetime Warranty

see website for details www.kraususa.com

Kraus USA Customer Service

1.800.775.0703 | customerservice@kraususa.com

REV. January 26, 2021

ST-4

Stainless Steel Kitchen Sink Strainer

Strainer Dimensions

Overall Dimensions: $\phi 1\frac{1}{2}$ " x $2\frac{5}{8}$ "

Features

- Premium Stainless Steel construction
- Fits Standard $3\frac{1}{2}$ " or 4" Drain Opening
- Removable Strainer Prevents Debris from Clogging Drain Pipe
- Tailpiece Included
- Decorative Stainless Steel Cover Fits Over Drain



Warranty

Kraus 1 Year Limited Warranty

see website for details www.kraususa.com

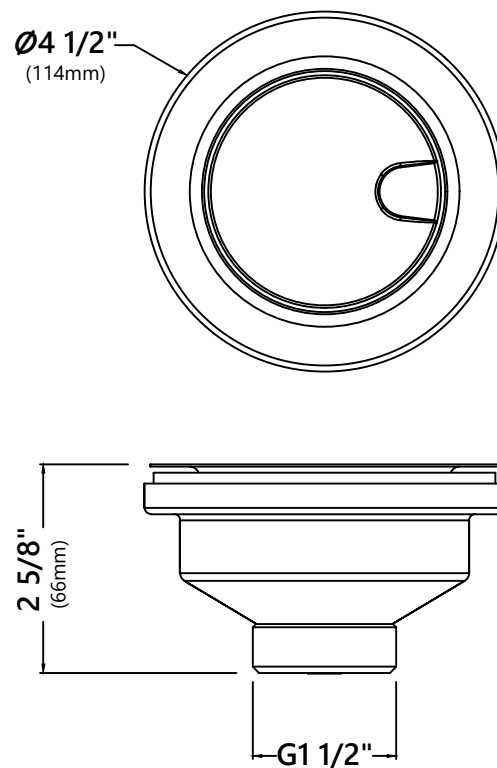

KCB-WS303

Cutting Board

Cutting Board Dimensions

Overall Dimensions: 16 3/4" x 11" x 1/4"

Features

- Designed to Use Over the Sink and On the Counter
- BPA-free and FDA-approved
- Included with KGTW1-33, KGTW2-33 and KGTW12-33 kitchen sinks



Warranty

Kraus One Year Limited Warranty
see website for details www.kraususa.com

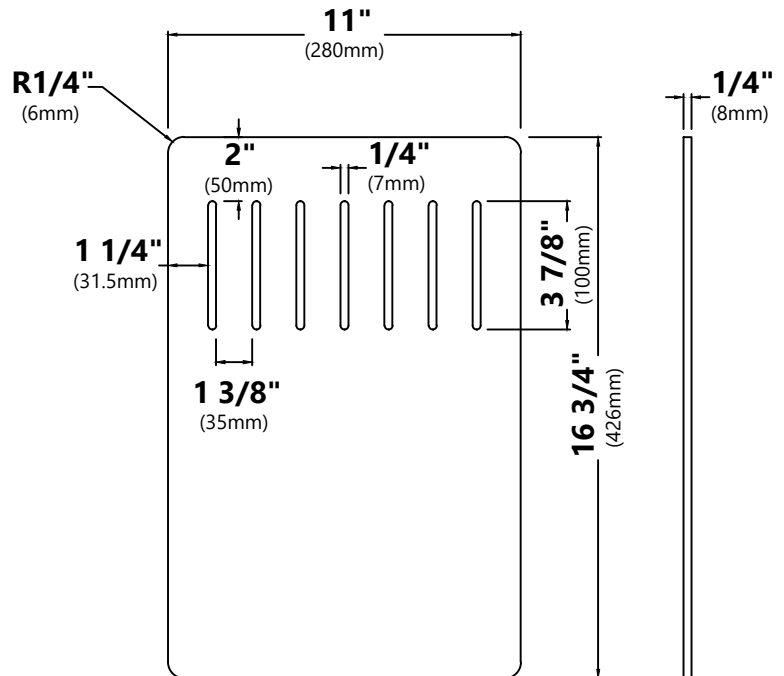

KRM-11

Multipurpose Roll-Up Dish Drying Rack

Rolling Mat Dimensions

Overall Dimensions: 16 7/8" x 12" x 3/8"

Features

- Roll-up over-the-sink drying rack
- Stainless steel construction with non-slip silicone coating
- Rolls up into a compact cylinder for storage
- Dishwasher safe
- Heat-safe up to 400° F
- Holds up to 100 lbs
- BPA-free and FDA-approved
- For Use with KFR4-33, KGF1-30, KGF1-33, KGF2-30, KGF2-33, KWF210-30, KWF210-33, KWF210-36, KWF410-30, KWF410-33, KWF410-36, KWT310-30, KWT310-33, KWT311-25, KWU110-27, KWU110-30, KWU110-32, KWU111-17, KWU111-23, KWU112-33, KWU120-45 and KWU210-57 kitchen sinks

Available Colors

- Black
- Brown
- Dark Blue
- Dark Grey
- Light Grey
- Aqua
- Green
- Red
- Yellow

Warranty

Kraus One Year Limited Warranty
see website for details www.kraususa.com

