

**Features**

- Solid brass construction
- 8.25" (21.0 cm) spout reach (wall-to-center)
- 1/2" NPT spout inlet fitting
- Rough valve incorporates a brass valve body assembly
- Rough valve incorporates quarter-turn washerless ceramic disc valve cartridges
- Intended for use with Newport Brass rough valve as specified (Required Accessory)
- ADA Compliant
- 1.2 GPM (4.5 LPM) Max

**Wall-Mounted Lavatory Faucet**

**3-3321**



**Codes / Standards Compliance**

Meets or exceeds the following at date of manufacture:

- ASME A112.18.1/CSA B125.1
- IAMPO/cUPC
- NSF/ANSI/CAN 61, SECTION 9
- NSF/ANSI 372
- IPC
- ADA & ICC/ANSI A117.1
- Energy Policy Act of 1992
- EPA WaterSense
- California Energy Commission
- All applicable US Federal and State material regulations



**Colors / Finishes**

- 10B: Oil Rubbed Bronze
  - 15: Polished Nickel
  - 15S: Satin Nickel - PVD
  - 26: Polished Chrome
- Other: Refer to the Newport Brass catalog for additional color/finish options.

**Specified Model**

Model	Description	Colors   Finishes
3-3321	Wall-Mounted Lavatory Faucet	<input type="checkbox"/> 10B <input type="checkbox"/> 15 <input type="checkbox"/> 15S <input type="checkbox"/> 26 <input type="checkbox"/> Other

**Product Specification:** Add size designator and "Color / Finish" suffix to Model number, below.

The Wall-Mounted Lavatory Faucet shall be made of solid brass construction. Wall-Mounted Lavatory Faucet shall incorporate lever handles and a 8.25" (21.0 cm) spout (wall-to-center) that incorporates a 1/2" NPT inlet fitting. Rough valve shall incorporate a brass valve body assembly and quarter-turn washerless ceramic disc valve cartridges. Wall-Mounted Lavatory Faucet shall be Newport Brass Model 3-3321/\_\_\_\_ and Newport Brass rough valve shall be 1-532U.

# 3-3321

Product Dimensions are provided for reference only. For specific product installation guidelines, please reference the Installation Instructions of the product being installed.

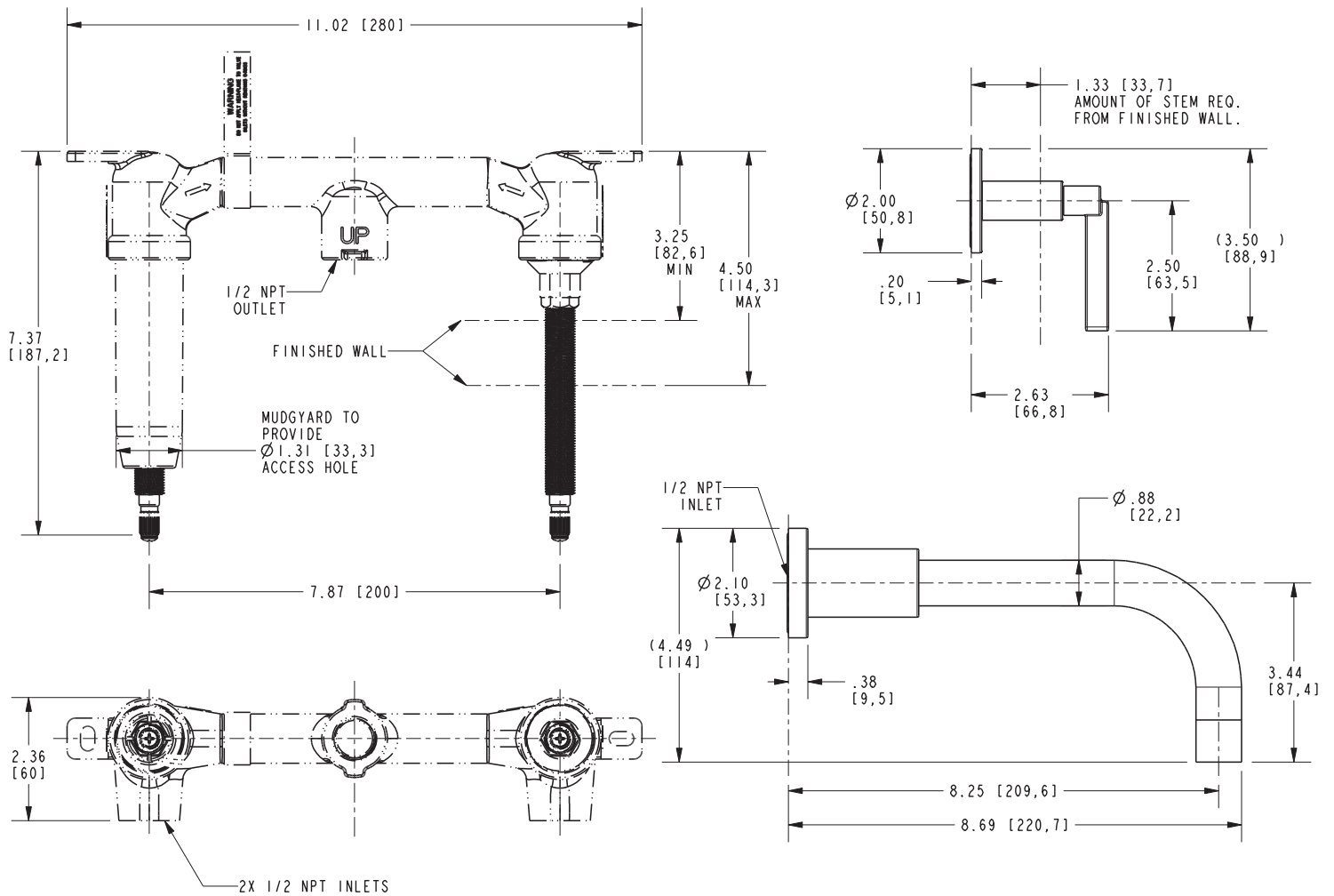

## Tolmin Wall-Mounted Lavatory Faucet 3-3321