

Radford RAD-N-SW

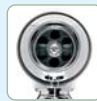

Recommended: STD-UNI-XX



STD-UNI-PC STD-UNI-PN
 STD-UNI-PB STD-UNI-ORB
 STD-UNI-BN STD-UNI-AB



FT-RAD-SW



FT-RAD-WH



FT-RAD-PC



FT-RAD-PB



FT-RAD-PN



FT-RAD-BN



FT-RAD-AB

SW ENGLISHCAST® white, blanc, Bianco
 WH White metal, Métal blanc, de color blanco
 PC Polished chrome, Chromé, Cromado brillante
 PB Polished brass, Doré, Latón pulido

BC Brushed nickel, Nickel mat, Niquel satinado
 PN Polished nickel, Nickel brillant, Niquel brillante
 ORB Oil rubbed bronze, Huillé fini bronze, Bronce aceitado
 AB Aged bronze, Bronze Vieilli, Bronce envejecido

🇺🇸 🇨🇦 Classic double-ended tub

- Made from ENGLISHCAST®
 - One piece casting of volcanic limestone and resin
 - Harder & more durable than acrylic
- Easy clean high gloss finish
- Exterior can be painted
- 25 year warranty

🇫🇷 Baignoire classique à double assise

- Fabrication en ENGLISHCAST®
 - Ensemble d'une pièce en pierre volcanique rare et résine Coulage
 - Matériau plus dur et plus résistant que l'acrylique
- Finition brillante facile à nettoyer
- L'extérieur peut être peint
- Garantie de 25 ans

🇪🇸 Bañera clásica con doble espalda

- Hecho de ENGLISHCAST®
 - Hecho en una pieza de piedra volcánica y resina
 - Más resistente y duradero que acrílico
- Fácil de limpiar y acabado brillante
- El exterior se puede pintar
- 25 años de garantía



Massachusetts Code:P1-0513-449
 cUPC listing by IAPMO: File No. 6574
 Registered Design



Scan to view product page,
 and all downloadable content

Radford RAD-N-SW

Top view

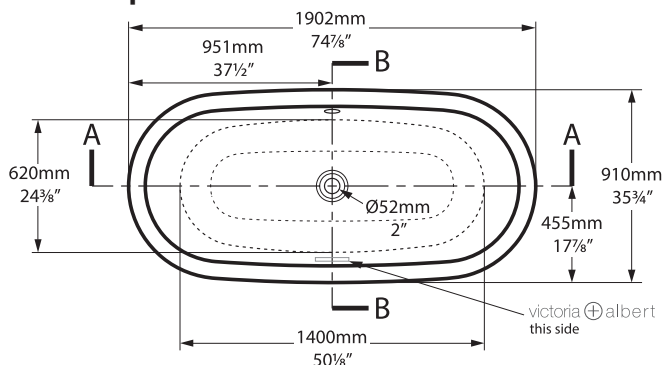

Front view

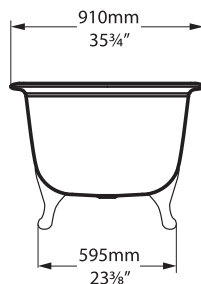

Section BB

Shown with STD-UNI Waste kit

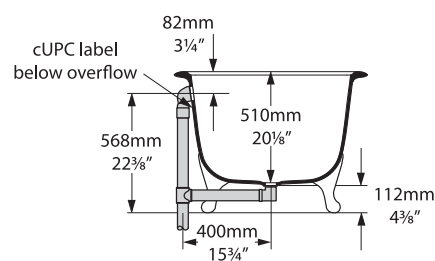

Side view

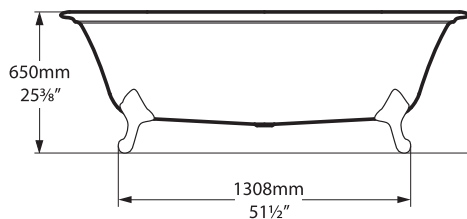

Section AA

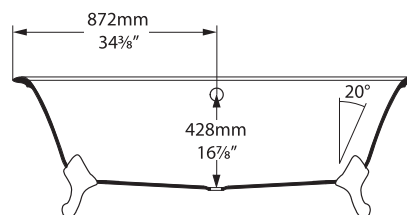

Rim Detail

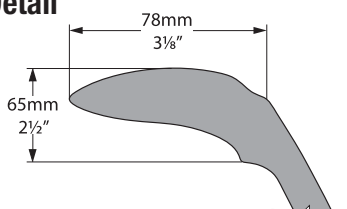

*All measurements subject to +/-5% tolerance

